

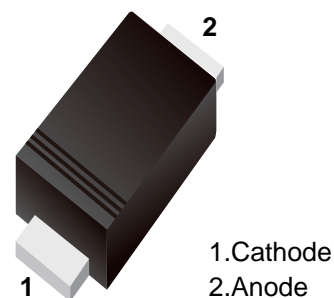

High Voltage Switching Diode

FEATURES

- Ultra small plastic SMD package
- High continuous reverse voltage: 300V
- Repetitive peak forward current: 250 mA
- High switching speed: max. 50ns



■ Simplified outline(SOD-523)

Top View 

APPLICATIONS

- High speed switching.
- High voltage switching.

MAXIMUM RATING @ Ta=25°C unless otherwise specified

Parameter	Symbol	Limits	Unit
Repetitive peak reverse voltage	V_{RRM}	300	V
Continuous reverse voltage	V_R	300	V
Continuous forward current $T_s \leq 90^\circ\text{C}$; Note 1	I_F	250	mA
Repetitive forward current $t_p = 1\text{ms}$	I_{FRM}	1	A
Non-repetitive peak forward surge current $t_p = 1\text{ms}$; square wave; $T_j = 25^\circ\text{C}$ prior to surge	I_{FSM}	4.5	A
Total power dissipation $T_s \leq 90^\circ\text{C}$; Note 1	P_{tot}	500	mW
Junction temperature	T_j	150	$^\circ\text{C}$
Storage And operating ambient temperature	T_{stg}, T_{amb}	-65 to +150	$^\circ\text{C}$

Note

1. T_s is the temperature at the soldering point of the cathode tab.

■ Marking

Marking	L4
---------	----

ELECTRICAL CHARACTERISTICS @ Ta=25°C unless otherwise specified

Parameter	Symbol	Conditions	Min.	Typ.	Max.	Unit
breakdown voltage	V_{BR}	$I_R=100\mu A$	300	340		V
Forward voltage	V_F	$I_F=100mA$		0.95	1.1	V
Reverse current	I_R	$V_R=250V$		30	150	nA
		$V_R=250V, T_J=150\text{ }^\circ C$		40	100	μA
Diode capacitance	C_d	$V_R=0, f=1MHz$		0.4	5	pF
Reverse recovery time	t_{rr}	when switched from $I_F=30mA$ to $I_R=30mA$; $R_L=100\Omega$; measured at $I_R=3mA$		16	50	ns

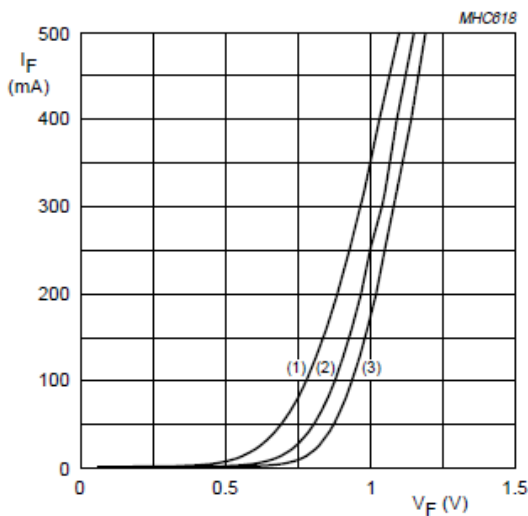
TYPICAL CHARACTERISTICS @ Ta=25°C unless otherwise specified

- (1) $T_{amb} = 150\text{ }^\circ C$.
- (2) $T_{amb} = 75\text{ }^\circ C$.
- (3) $T_{amb} = 25\text{ }^\circ C$.

Fig 1 Forward current as a function of forward voltage; typical values.

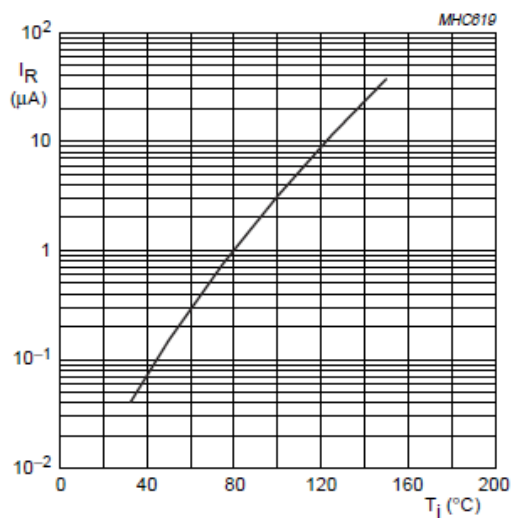

$V_R = V_{Rmax}$; typical values.

Fig 2 Reverse current as a function of junction temperature.

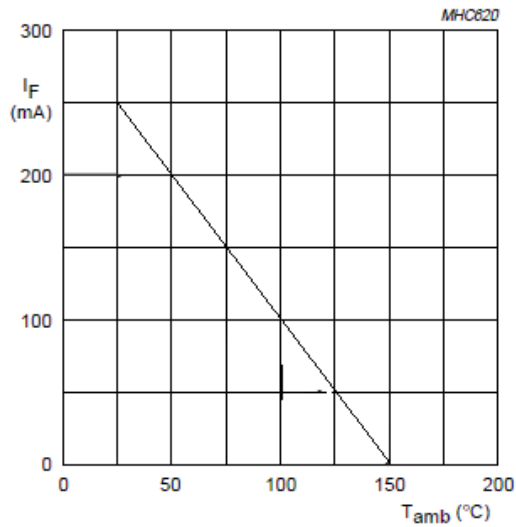

Fig 3 Maximum permissible continuous forward current as a function of ambient temperature.

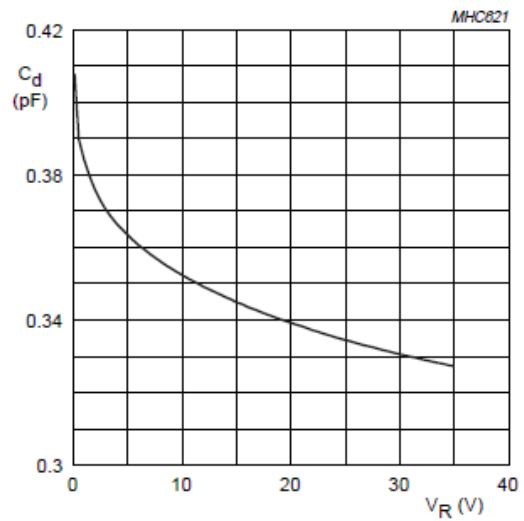
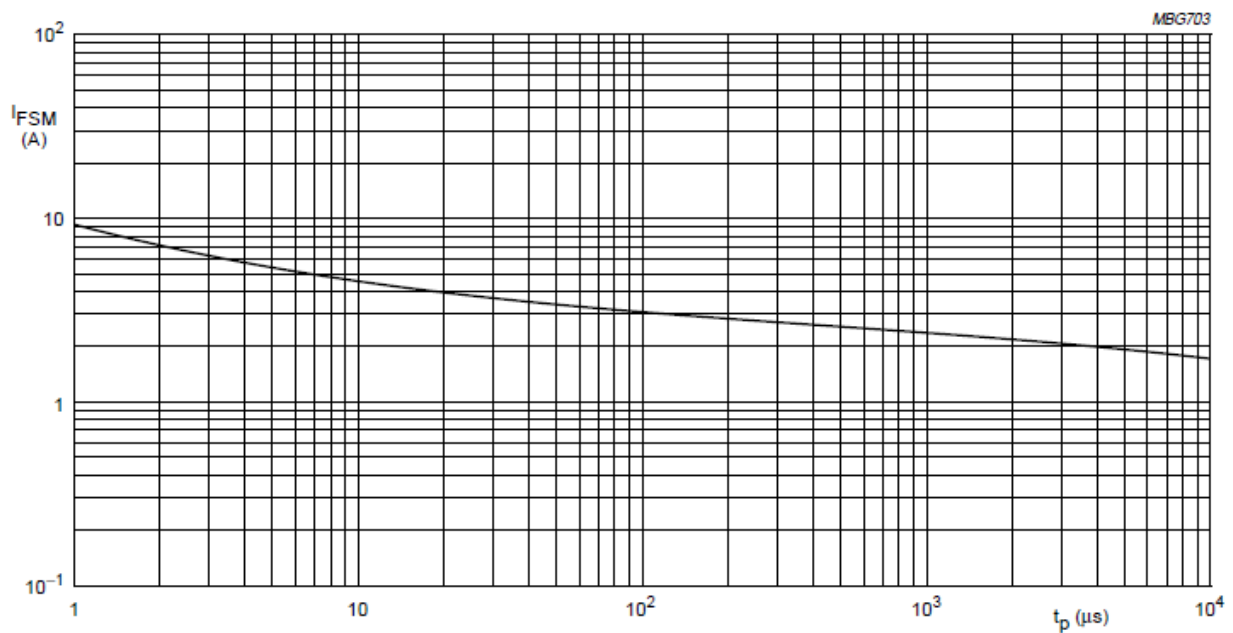

Fig 4 Diode capacitance as a function of reverse voltage; typical values.



Based on square wave currents.
 $T_j = 25^\circ\text{C}$ prior to surge.

Fig 5 Maximum permissible non-repetitive peak forward current as a function of pulse duration.

PACKAGE OUTLINE

Plastic surface mounted package

SOD-523

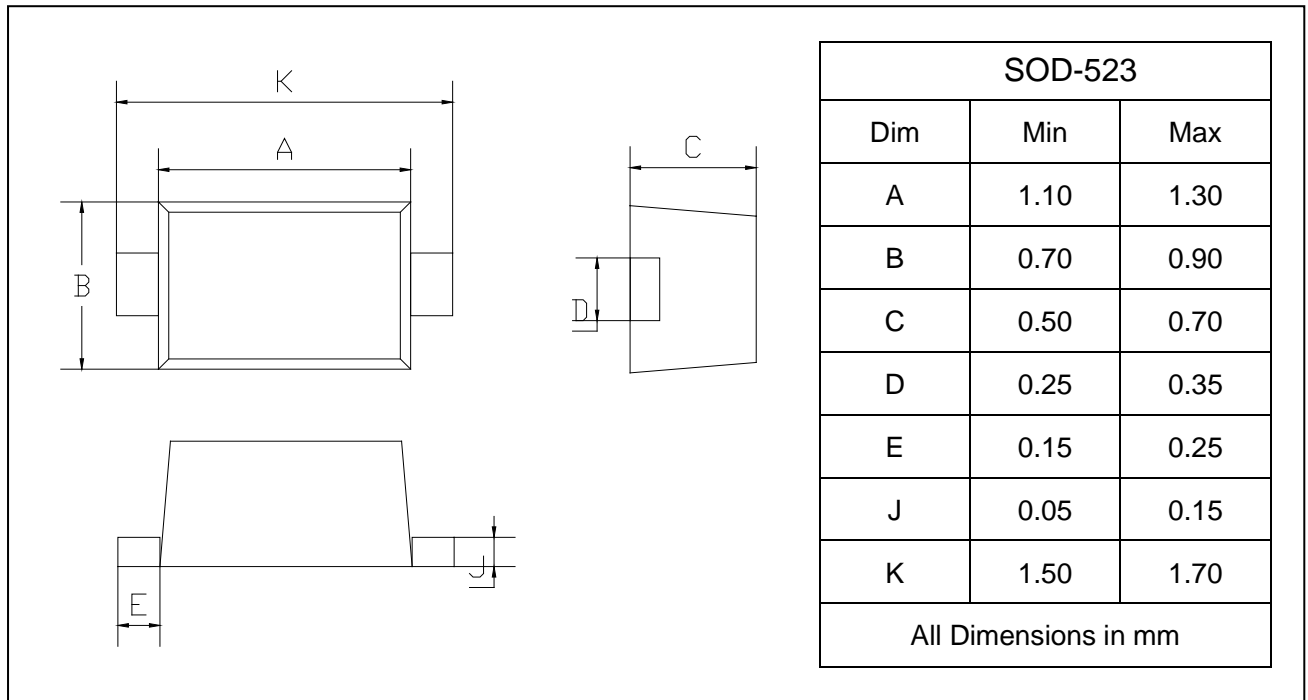

SOLDERING FOOTPRINT

